

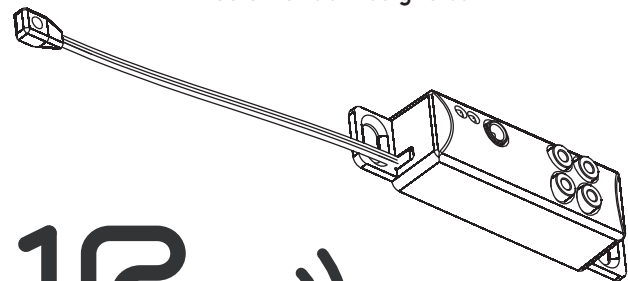

SALAMANDER
DESIGNS

SalamanderDesigns.com



12
all in one
users guide

Doc #500-160 v12.08

1. Mounting IR Hub

Mounting to Salamander Furniture with Aluminum Frame

Use two Drop-In Nuts with two Button Head Screws to mount Hub on the inside or backside of cabinet attaching to aluminum post.

Slip nut into slot and tighten the button head screw to lock the nut into place.

Note: Nut must slant from top left to bottom right as shown below.

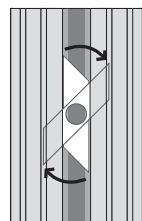
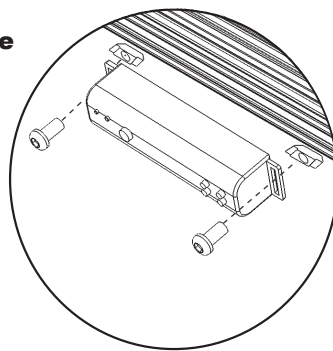

Mounting to Wood Cabinets

Use supplied wood screws to mount Hub to interior or exterior of cabinet.



IR ALL IN ONE includes these items:

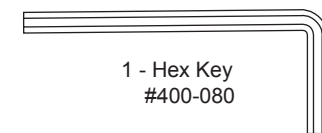

1 - Hex Key
#400-080

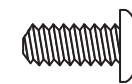

2 - Button Head Screws
#300-518

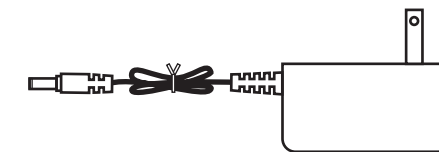

1 - Power Supply
#056-007 (USA)
#900-040 (EU,UK)

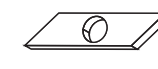

2 - Drop-in Nuts
#300-565

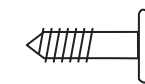

2 - Wood Screws
#300-115

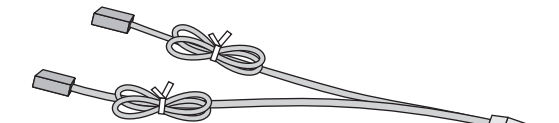

2 - IR Emitters
#IR-3002

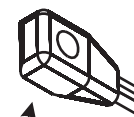

IR Receiver

36"



4 - IR Emitter Holders
#440-297

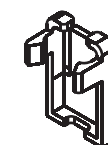

1 - IR Receiver Holder
#440-296



6 - Wire Managers
#440-322

LED Status Indicators:
Power and IR Data

DC Power Input

4 IR Emitter outputs

2. Attach IR Receiver

Attach Receiver Holder to front of cabinet and place the IR Receiver in holster.

Note: IR Receiver should be placed within sight.

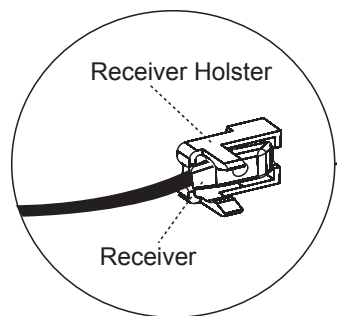

Receiver Holder

Receiver

3. Attach Emitters

Attach IR Emitter Holders in front of IR sensors of each component and place the IR Emitter in holster.

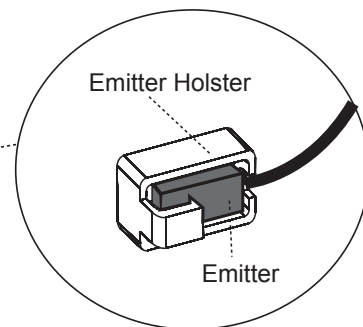

Emitter Holder

Emitter

Note: Be sure the Emitter is securely attached directly over the component's IR receptor. To locate the IR receptor, shine a flashlight at the unit and look for the sensor.

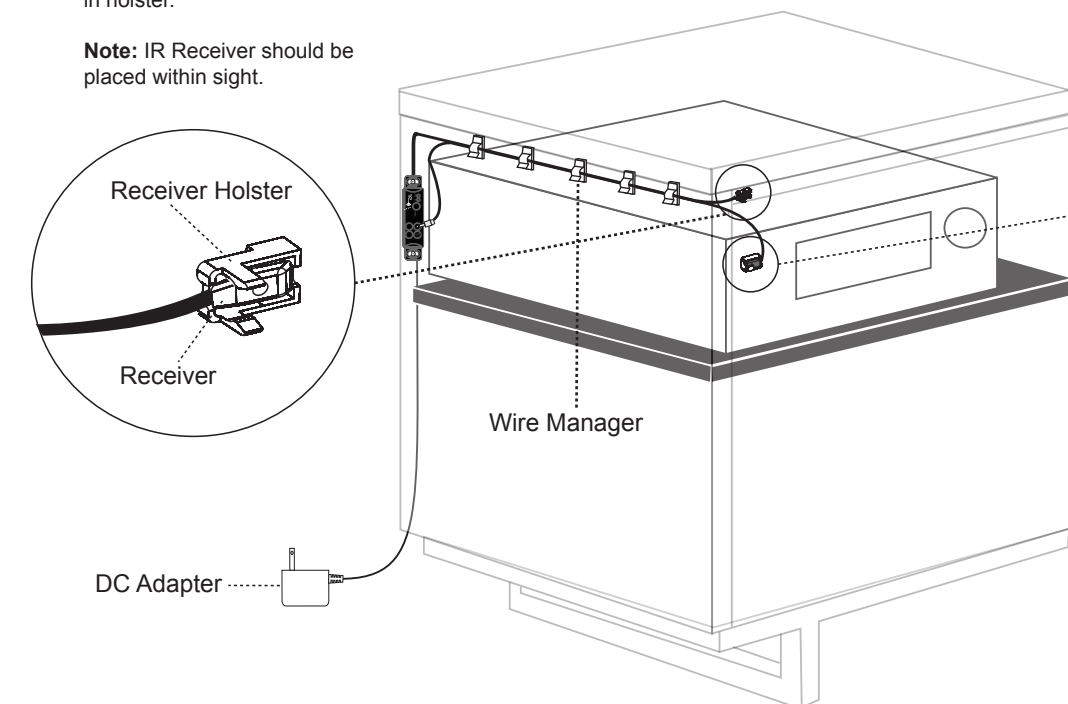

Wire Manager

DC Adapter

Features

- IR remote is compatible with any A/V component that has the All-In-One Solution by Salamander Designs.
- The plasma proof remote head IR receiver uses advances optical and electronic filtering for interference rejection.
- LED lights provide power and IR signal status.
- A 2-piece design makes it easy to conceal and simple to install.

Specifications

Specifications:	(Typical)
Power Supply:	USA: In: 110V - 120V EU, UK: In: 120V - 240V, 50 - 60Hz Out: 8 - 12V
IR Freq. Range Supported:	30 kHz - 60 kHz
IR Pickup Range:	40 ft. @ 38kHz, 25 ft. @ 56kHz
IR Receiver Head Dimensions:	0.65" x 0.35" x 0.25"
IR Emitter Outputs:	4* (expandable to 8)

*Compatible with Channel Vision™ IR-3002

Specifications subject to change without notice.

Limited Warranty

Salamander Designs will repair or replace any defect in material or workmanship which occurs during normal use of this product with new or rebuilt parts, free of charge in the USA, for two years from the date of original purchase. This is a no hassle warranty with no mail in warranty card needed. This warranty does not cover damages in shipment, failures caused by other products not supplied by Salamander Designs, or failures due to accident, misuse, abuse, or alteration of the equipment. This warranty is extended only to the original purchaser, and a purchase receipt, invoice, or other proof of original purchase date will be required before warranty repairs are provided.

Mail in service can be obtained during the warranty period by calling toll-free (800) 535-5659. A Return Authorization number must be obtained in advance and can be marked on the outside of the shipping carton.

This warranty gives you specific legal rights and you may have other rights (which vary from state to state). If a problem with this product develops during or after the warranty period, please contact Salamander Designs, your dealer or any factory-authorized service center.